



AGI SRL

Via Mazzini, 57
21020 Mornago (VA)

Tel. 0331/993.656 - 993.657 Fax. 0331/992.959 E-mail:info@agigraphics.com www.agigraphics.com

Customer :
 Plant designation : CLEANING 140
 Drawing number : 001 CL140 PLC
 Commission :

Alimentation :
 Note :
 Note :

Created : 29.Dic.2017 Maximum number of page : 00006
 Drawing : 29.Dic.2017 da: AGI General number of pages : 9

REV.	DATE	DESCRIPTION	DATE	29.Dic.2017	Sheet description	 AGI SRL Via Mazzini,57 21020 Mornago (VA) Tel.0331/993.656 - 993.657 Fax.0331/992.959	001 CL140 PLC	
			MODIFY DATE	29.Dic.2017	COVER			PAGE 00000
			DRAWING	AGI				NEXT PAGE 00000a
			APPROVED	AGI				
			DB					

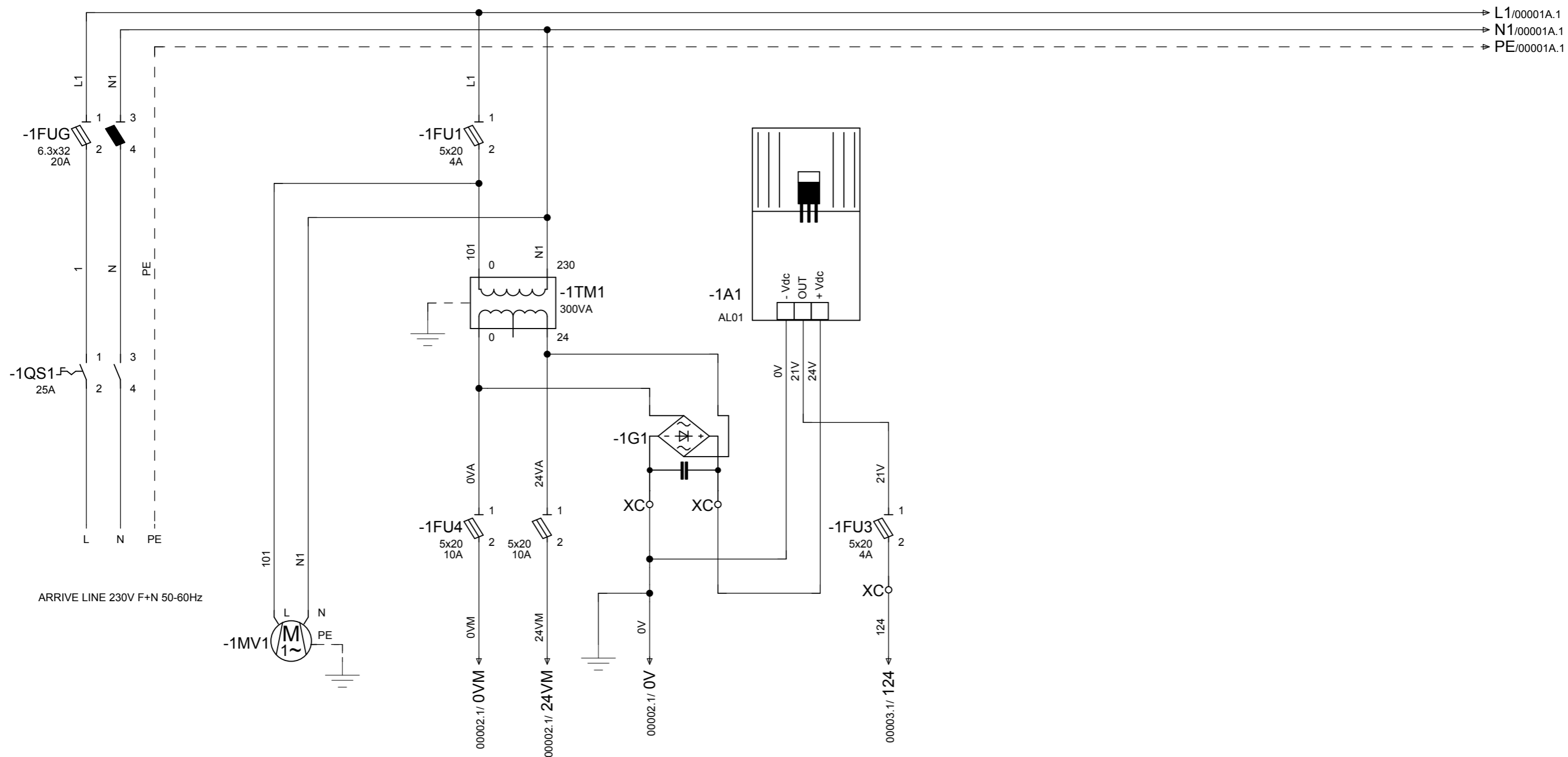

ARRIVE LINE 230V F+N 50-60Hz

MAIN SWITCH

ELECTRICAL CABINET EXHAUST

AUX ALIMENTATION

REV.	DATE	DESCRIPTION	DATE
			29.Dic.2017
			29.Dic.2017
			AGI
			AGI
			DB

Sheet description
ARRIVE LINE



AGI SRL
Via Mazzini,57
21020 Mornago (VA)
Tel.0331/993.656 - 993.657
Fax.0331/992.959

001 CL140 PLC	
PAGE	00001
NEXT PAGE	00001A

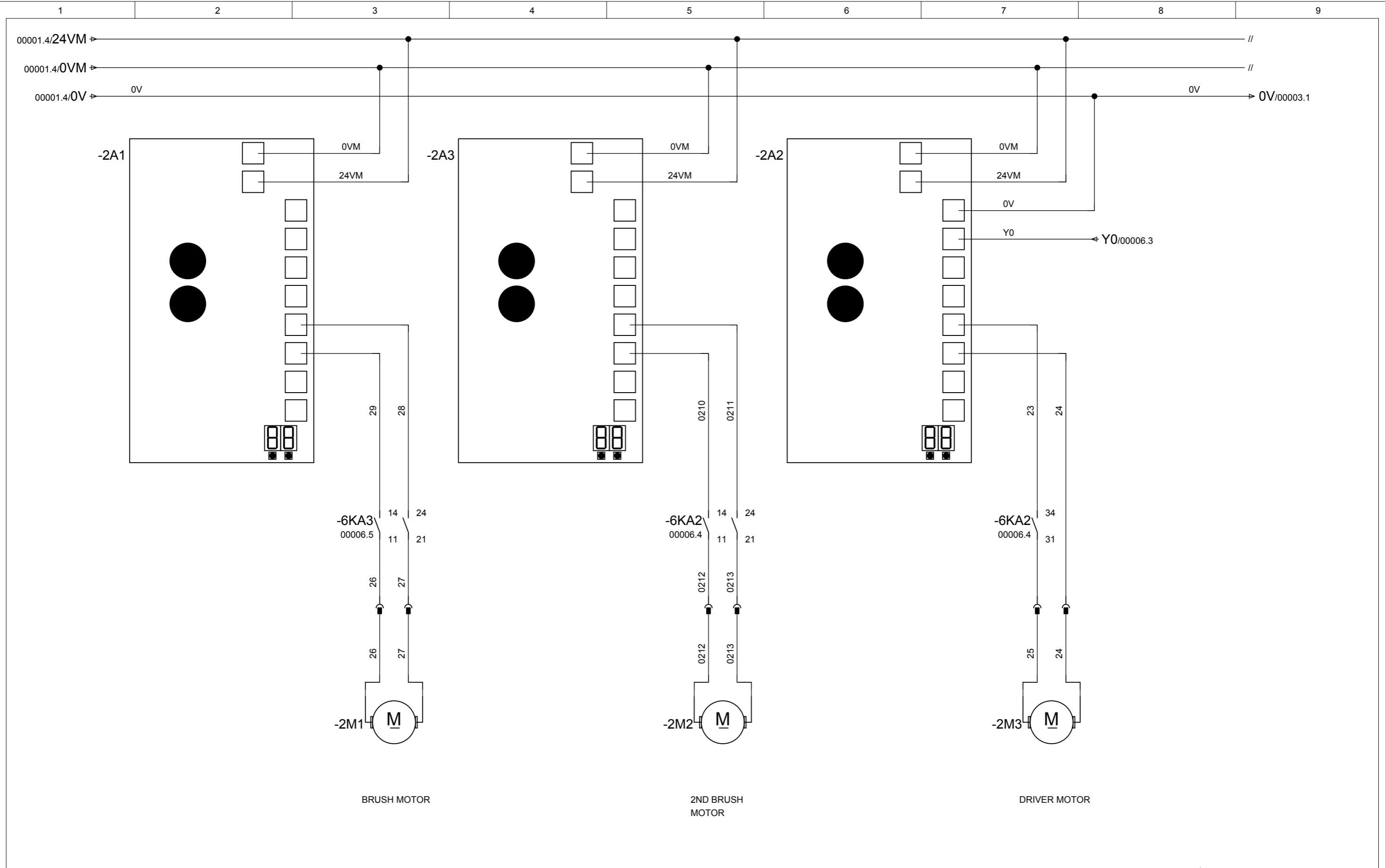

REV.	DATE	DESCRIPTION	DATE
			29.Dic.2017
			29.Dic.2017
			AGI
			AGI
			DB

Sheet description
MOTORS CARDS



AGI SRL
Via Mazzini,57
21020 Mornago (VA)
Tel.0331/993.656 - 993.657
Fax.0331/992.959

001 CL140 PLC	
PAGE	00002
NEXT PAGE	00003

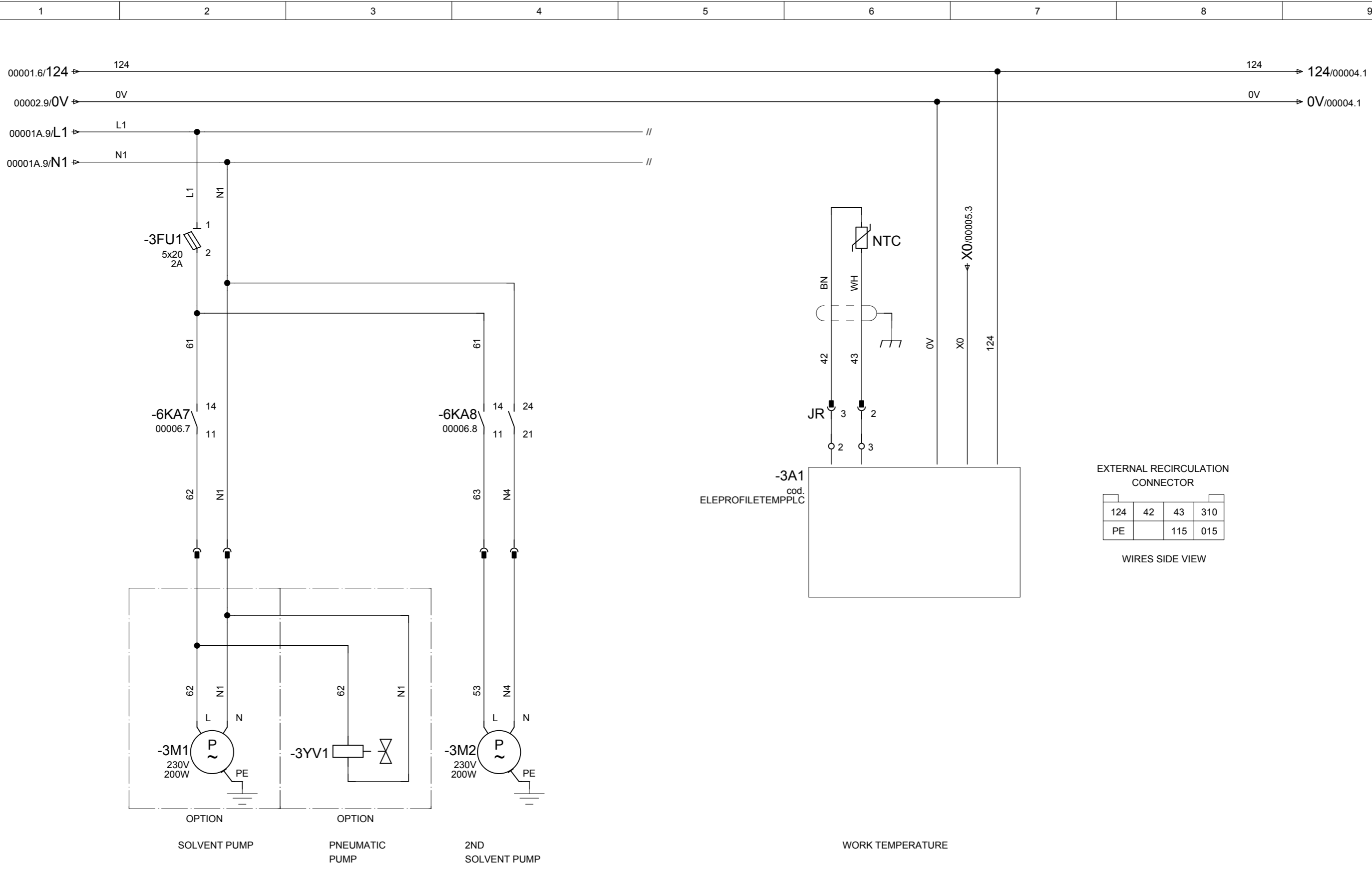

REV.	DATE	DESCRIPTION	DATE
			29.Dic.2017
			29.Dic.2017
			AGI
			AGI
			DB

Sheet description
 CARD TEMPERATURE



AGI SRL
 Via Mazzini,57
 21020 Mornago (VA)
 Tel.0331/993.656 - 993.657
 Fax.0331/992.959

001 CL140 PLC	
PAGE	00003
NEXT PAGE	00004

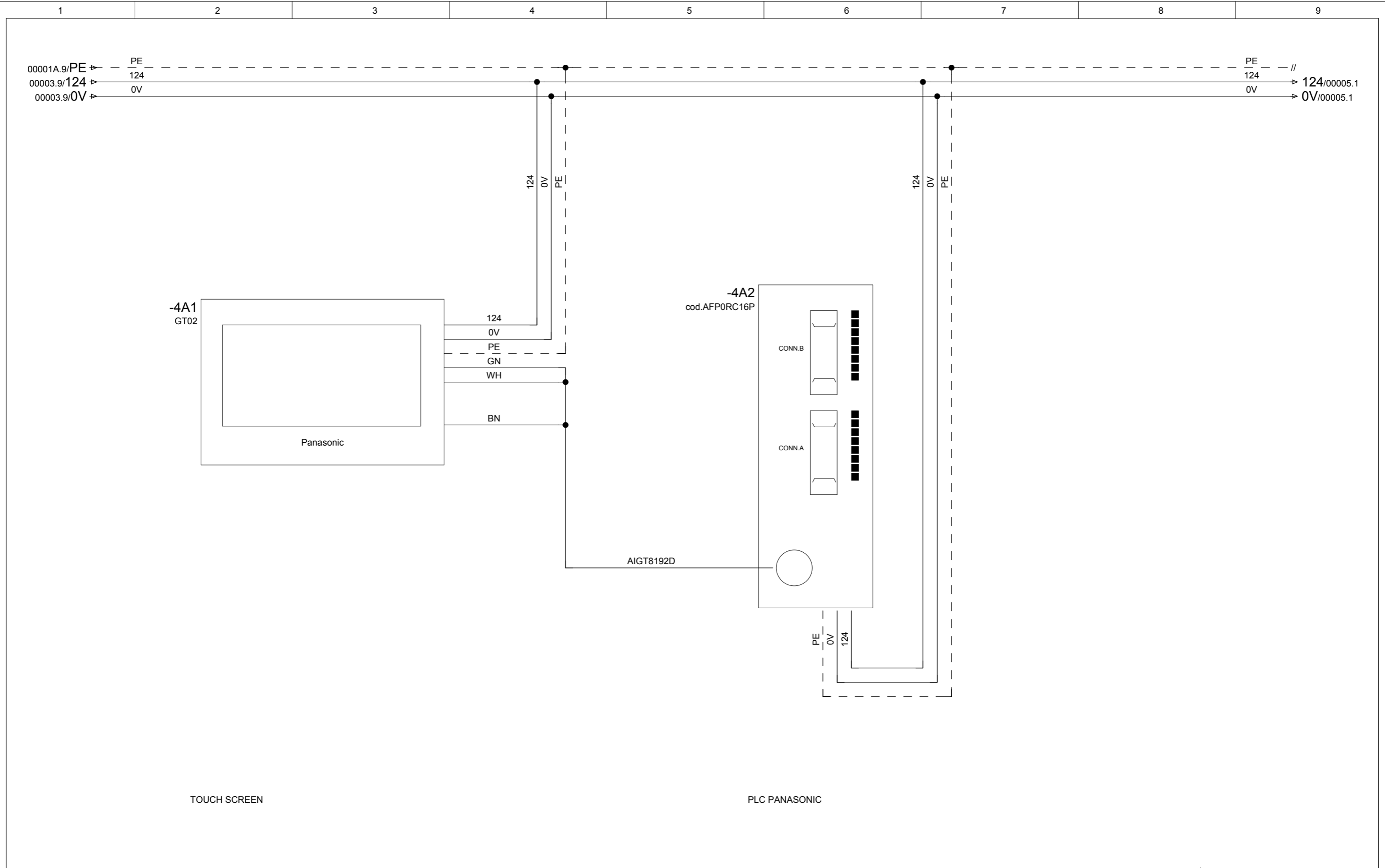

TOUCH SCREEN

PLC PANASONIC

REV.	DATE	DESCRIPTION	DATE
			29.Dic.2017
			29.Dic.2017
		DRAWING	AGI
		APPROVED	AGI
		DB	

Sheet description
 PLC AND TOUCH SCREEN



AGI SRL
 Via Mazzini,57
 21020 Mornago (VA)
 Tel.0331/993.656 - 993.657
 Fax.0331/992.959

001 CL140 PLC	
PAGE	00004
NEXT PAGE	00005

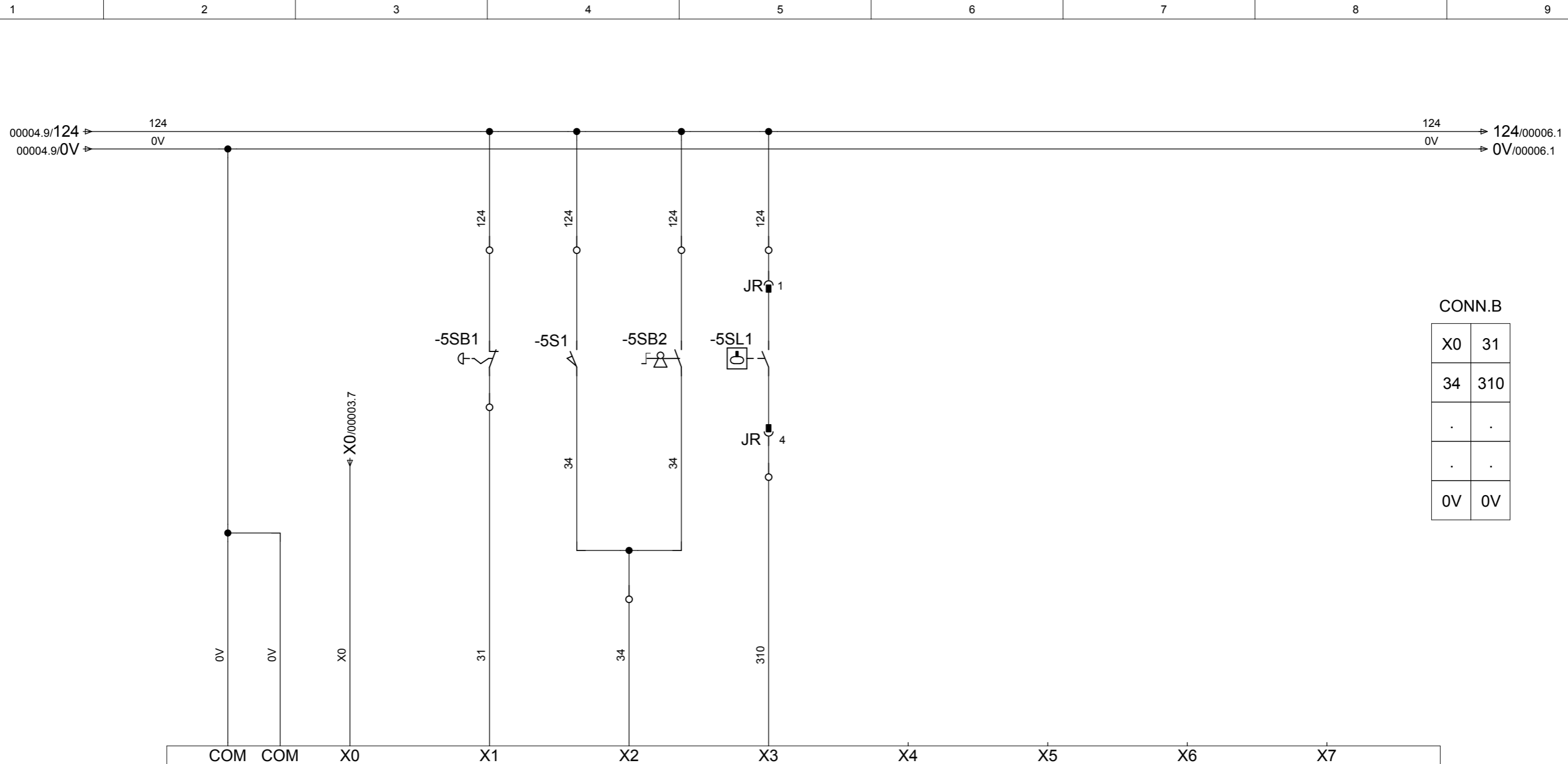

CONN.B

X0	31
34	310
.	.
.	.
0V	0V

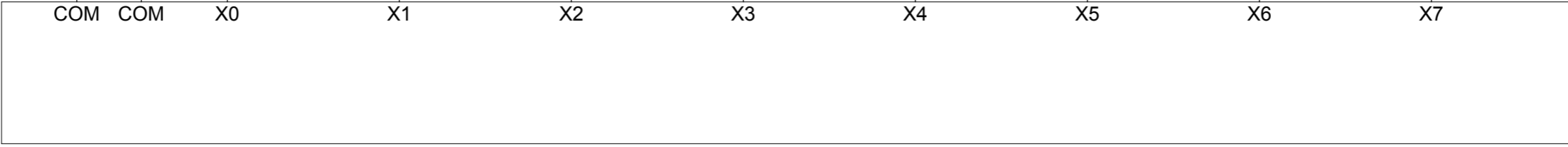

WORK TEMPERATURE
 EMERGENCY
 COVER MICROSWITCH
 SOLVENT LEVEL
 FREE
 FREE
 FREE
 FREE

REV.	DATE	DESCRIPTION	DATE	29.Dic.2017
			MODIFY DATE	29.Dic.2017
			DRAWING	AGI
			APPROVED	AGI
			DB	

Sheet description
 INPUT



AGI SRL
 Via Mazzini,57
 21020 Mornago (VA)
 Tel.0331/993.656 - 993.657
 Fax.0331/992.959

001 CL140 PLC	
PAGE	00005
NEXT PAGE	00006

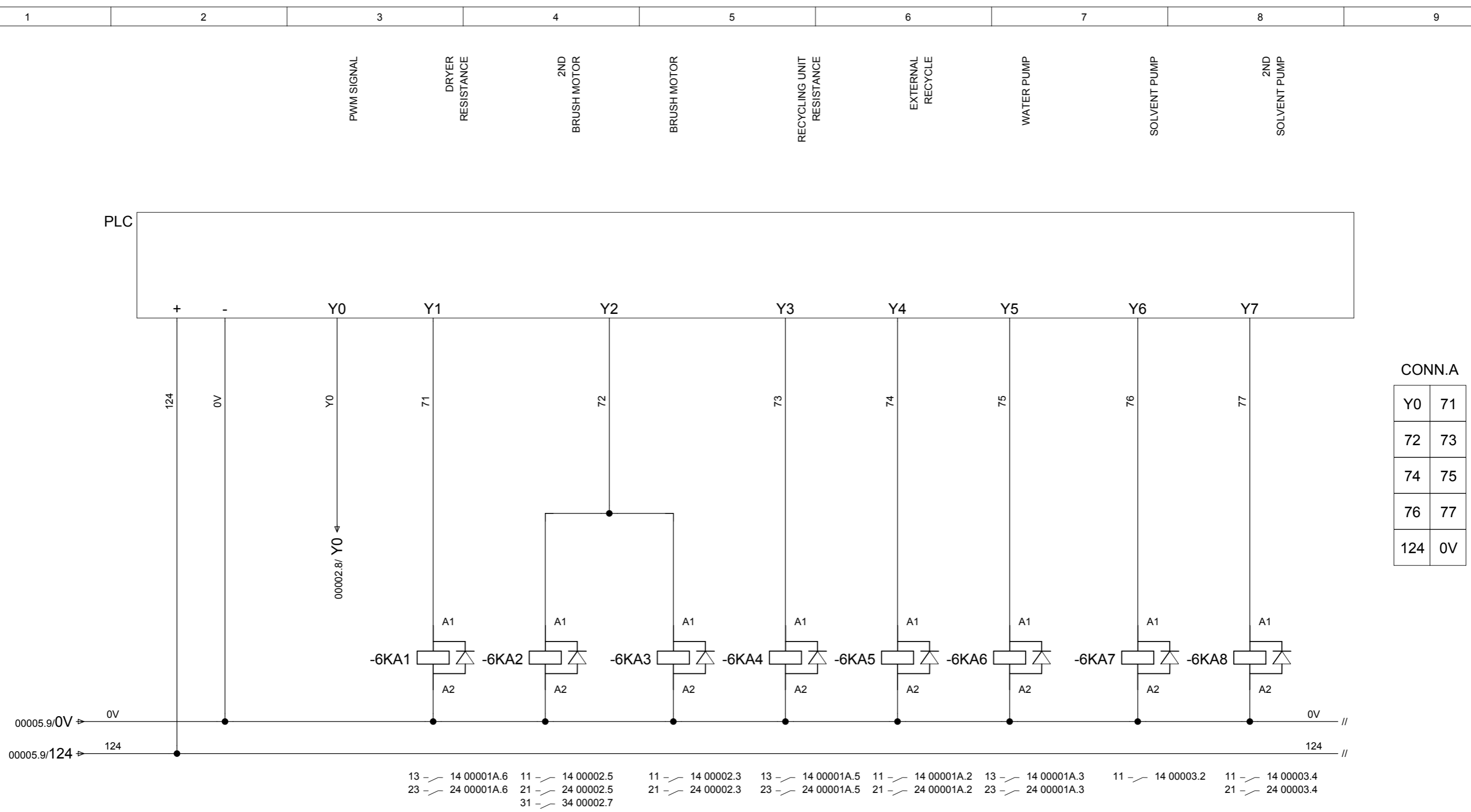

REV.	DATE	DESCRIPTION	DATE
			29.Dic.2017
			29.Dic.2017
		DRAWING	AGI
		APPROVED	AGI
		DB	

Sheet description
OUTPUT



AGI SRL
Via Mazzini,57
21020 Mornago (VA)
Tel.0331/993.656 - 993.657
Fax.0331/992.959

001 CL140 PLC	
PAGE	00006
NEXT PAGE	