



AGI SRL

Via Mazzini, 57  
21020 Mornago (VA)

Tel. 0331/993.656 - 993.657 Fax. 0331/992.959 E-mail:info@agigraphics.com www.agigraphics.com

Customer :  
 Plant designation :Cleaning 45  
 Drawing number :001 CL45 APR  
 Commission :  
  
 Alimentation :230V MONOPHASE 50-60Hz  
 Note :  
 Note :

Created :10.Mar.2014 Maximum number of page : 00006  
 Drawing :10.Mar.2014 da: AGI General number of pages : 8

REV.	DATE	DESCRIPTION	DATE	10.Mar.2014	Sheet description COVER	 AGI SRL Via Mazzini,57 21020 Mornago (VA) Tel.0331/993.656 - 993.657 Fax.0331/992.959	001 CL45 APR	
			MODIFY DATE	10.Mar.2014			PAGE	00000
			DRAWING	AGI			NEXT PAGE	00000a
			APPROVED	AGI				
			DB					



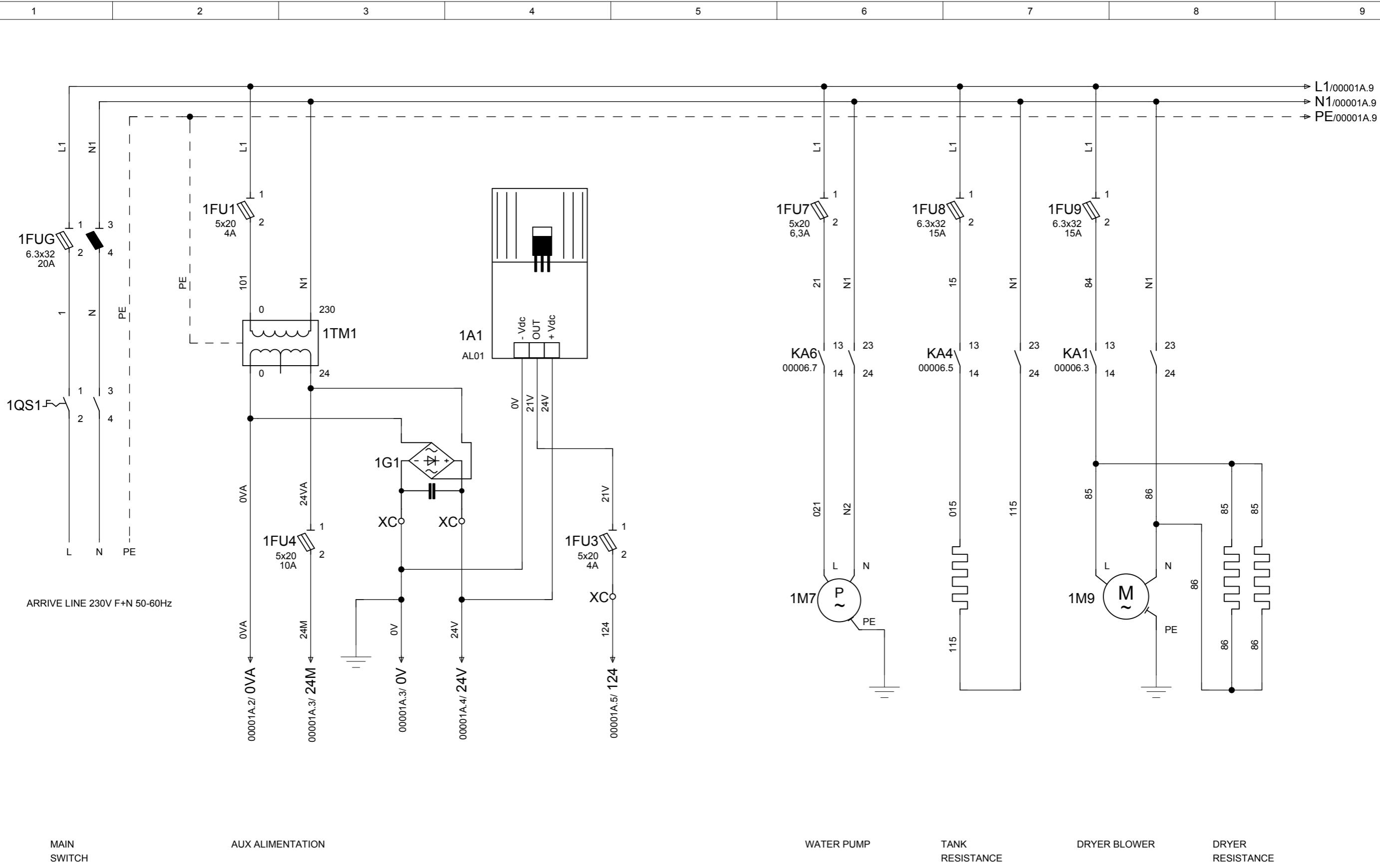

REV.	DATE	DESCRIPTION	DATE
			10.Mar.2014
			10.Mar.2014
			AGI
			AGI
			DB

Sheet description  
ARRIVE LINE

**AGI**  
Attrezzature Grafiche Italia

AGI SRL  
Via Mazzini,57  
21020 Mornago (VA)  
Tel.0331/993.656 - 993.657 Fax.0331/992.959

001 CL45 APR	
PAGE	00001
NEXT PAGE	00002

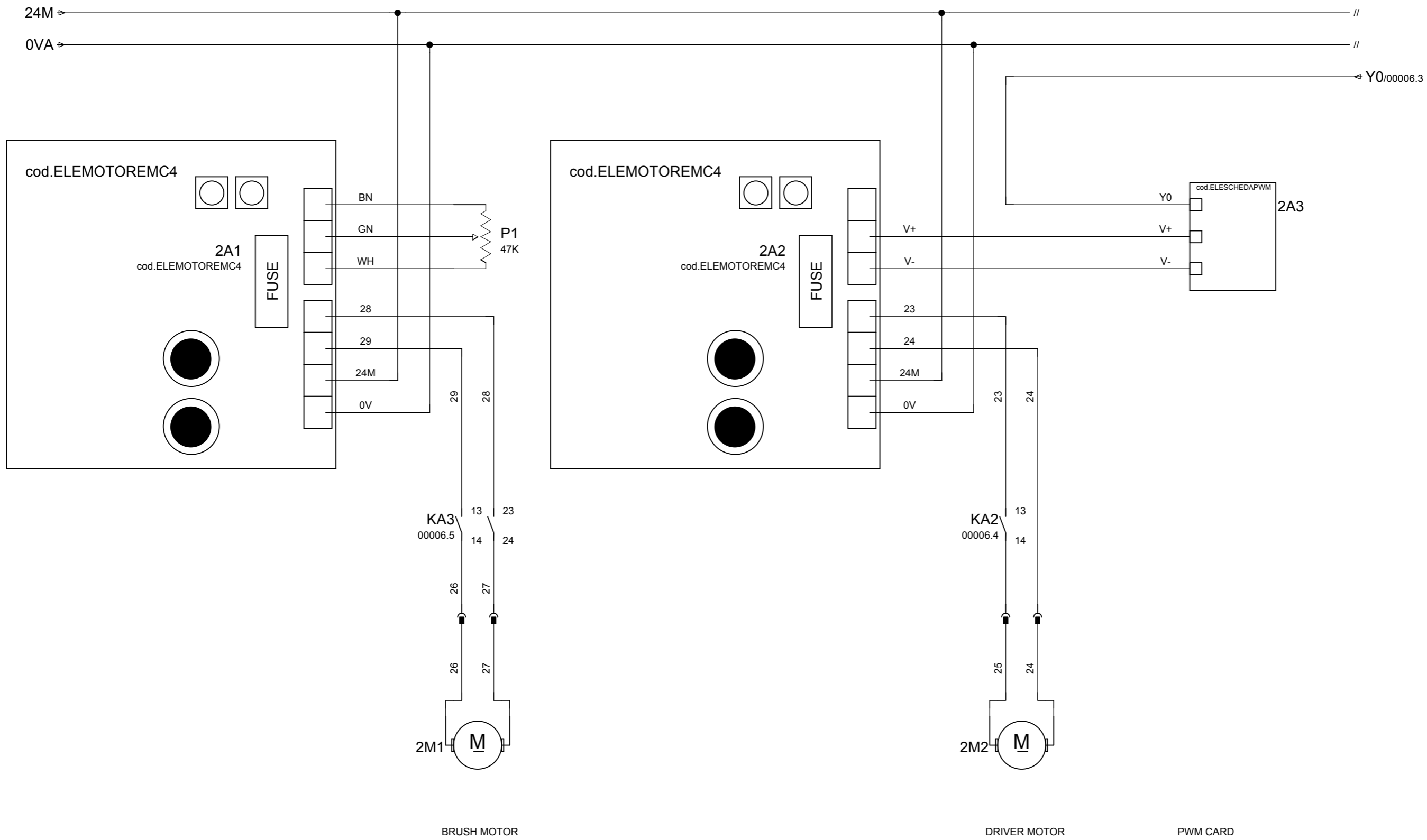

BRUSH MOTOR

DRIVER MOTOR

PWM CARD

REV.	DATE	DESCRIPTION	DATE
			10.Mar.2014
			10.Mar.2014
			AGI
			AGI
			DB

Sheet description  
MOTORS CARDS



AGI SRL  
Via Mazzini,57  
21020 Mornago (VA)  
Tel.0331/993.656 - 993.657 Fax.0331/992.959

001 CL45 APR	
PAGE	00002
NEXT PAGE	00003

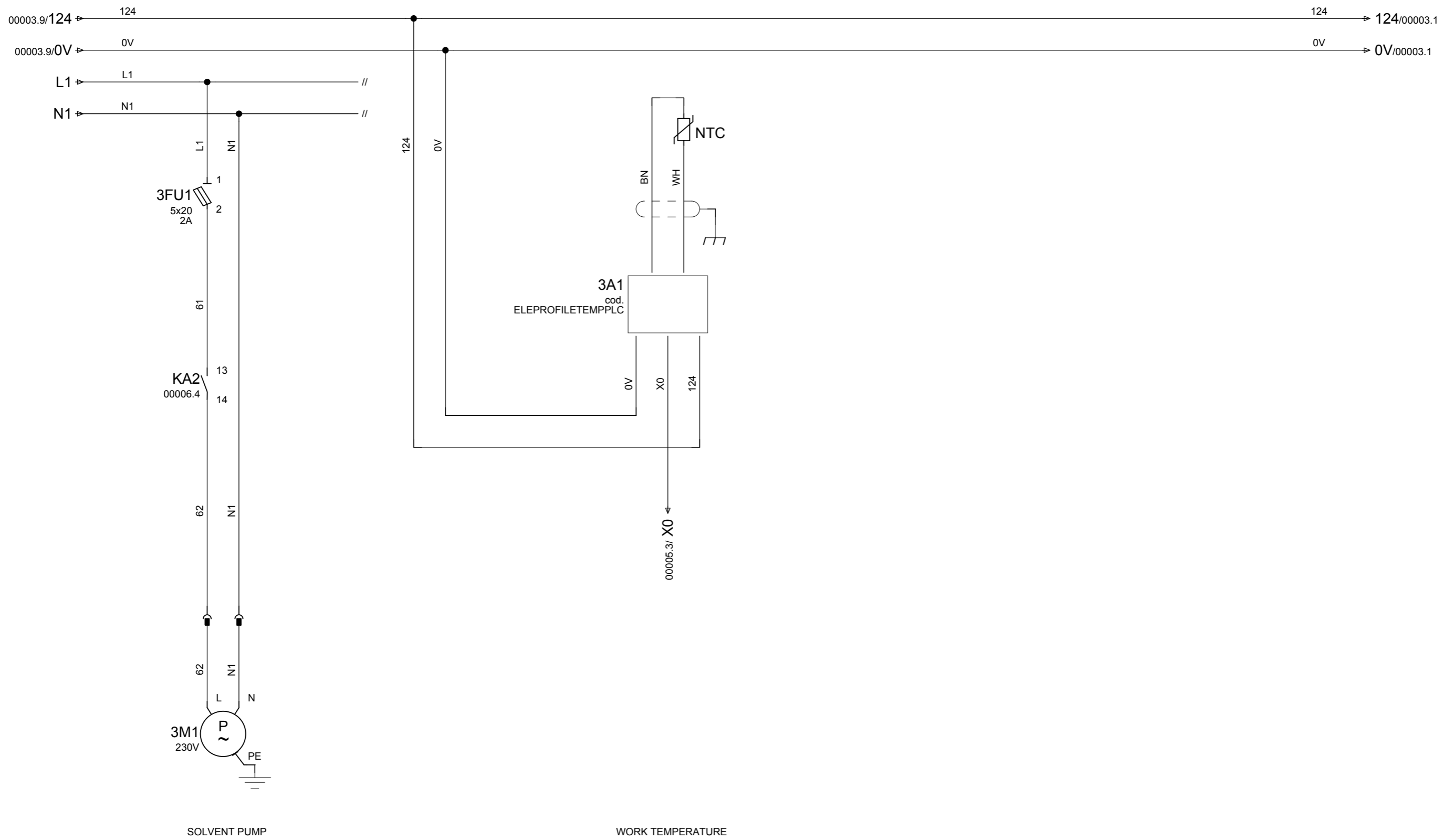

REV.	DATE	DESCRIPTION	DATE
			10.Mar.2014
			10.Mar.2014
			AGI
			AGI
			DB

Sheet description	AGI SRL
CARD TEMPERATURE	Via Mazzini,57 21020 Mornago (VA) Tel.0331/993.656 - 993.657 Fax.0331/992.959

AGI SRL  
Via Mazzini,57  
21020 Mornago (VA)  
Tel.0331/993.656 - 993.657 Fax.0331/992.959

001 CL45 APR	
PAGE	00003
NEXT PAGE	00004

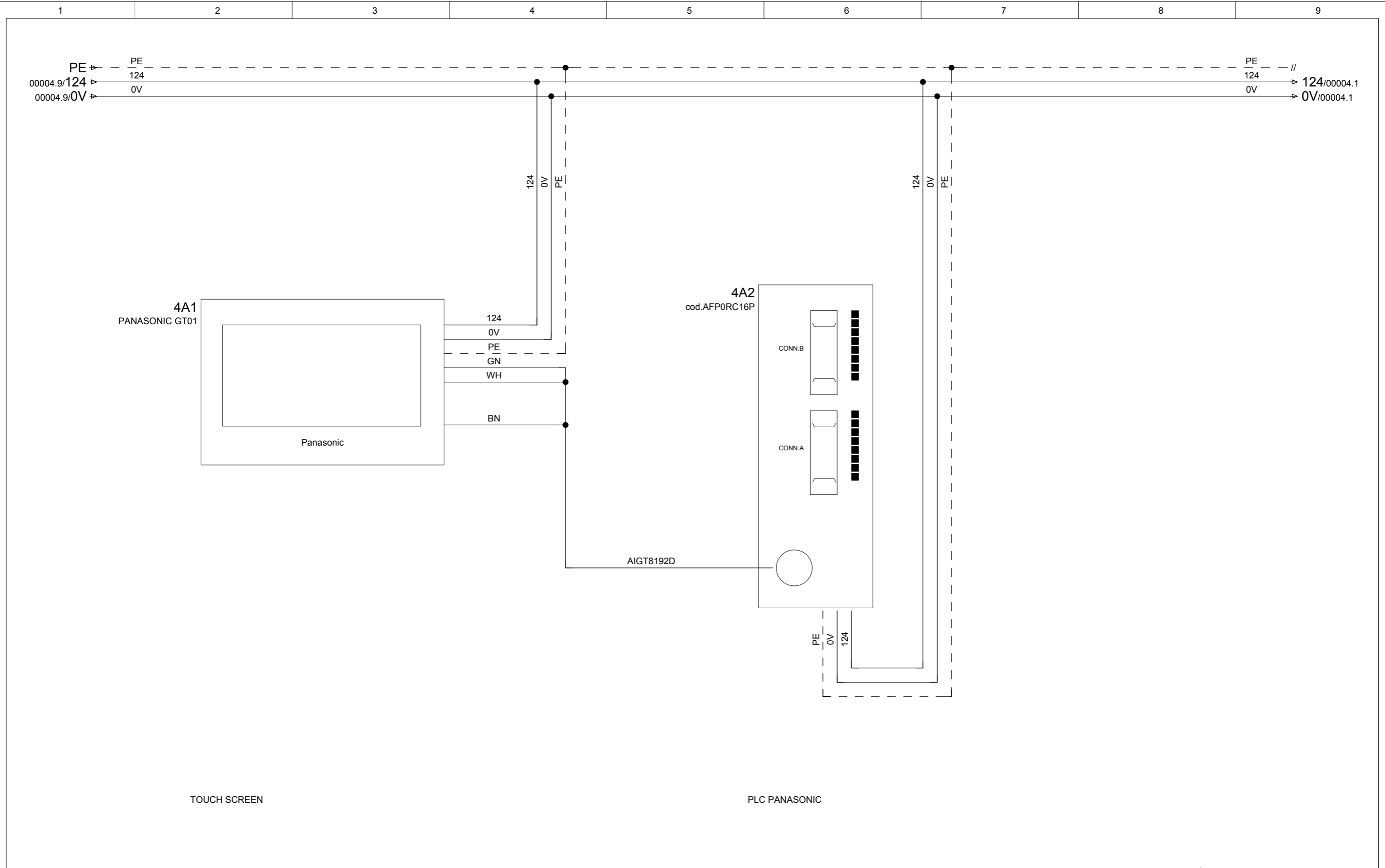

TOUCH SCREEN

PLC PANASONIC

REV.	DATE	DESCRIPTION	DATE
			10.Mar.2014
			10.Mar.2014
			AGI
			AGI
			DB

Sheet description  
PLC AND TOUCH SCREEN

**AGI**  
Attrezzature Grafiche Italia

AGI SRL  
Via Mazzini,57  
21020 Mornago (VA)  
Tel.0331/993.656 - 993.657 Fax.0331/992.959

001 CL45 APR	
PAGE	00004
NEXT PAGE	00005

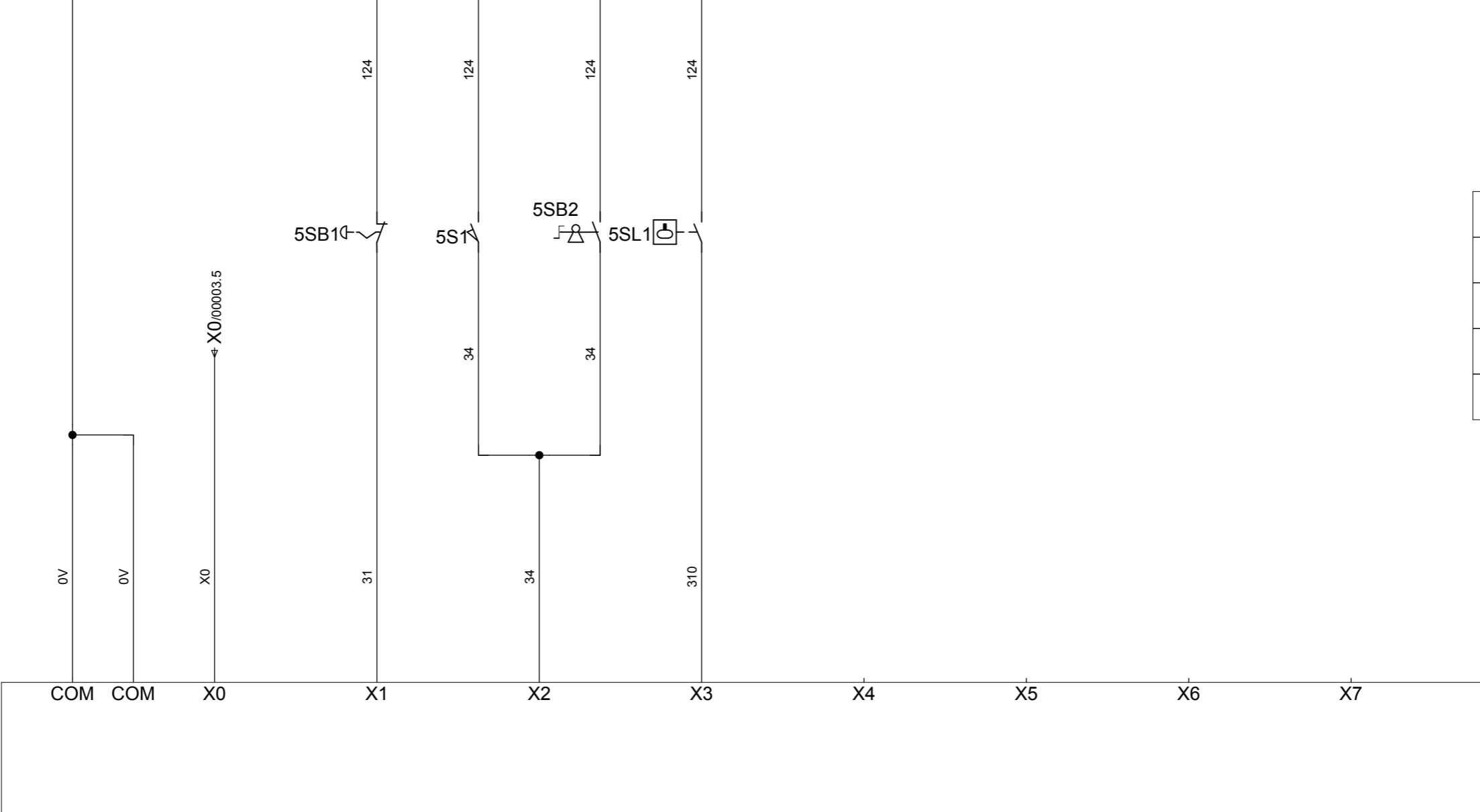
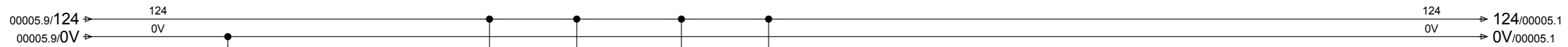

CONN.B

X0	31
34	310
.	.
.	.
0V	0V

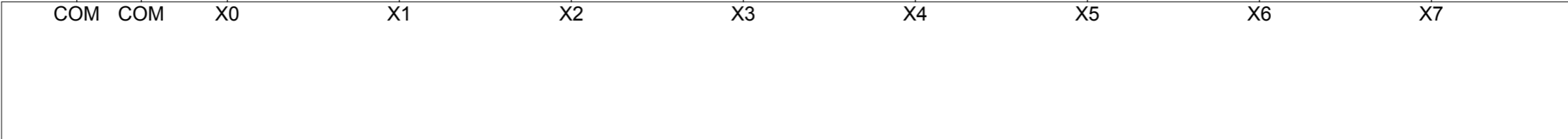

WORK TEMPERATURE  
EMERGENCY  
COVER MICROSWITCH  
SOLVENT LEVEL  
FREE  
FREE  
FREE  
FREE

REV.	DATE	DESCRIPTION	DATE	10.Mar.2014	Sheet description INPUT	 AGI SRL Via Mazzini,57 21020 Mornago (VA) Tel.0331/993.656 - 993.657 Fax.0331/992.959	001 CL45 APR	
			MODIFY DATE	10.Mar.2014			PAGE	00005
			DRAWING	AGI			NEXT PAGE	00006
			APPROVED	AGI				
			DB					

